

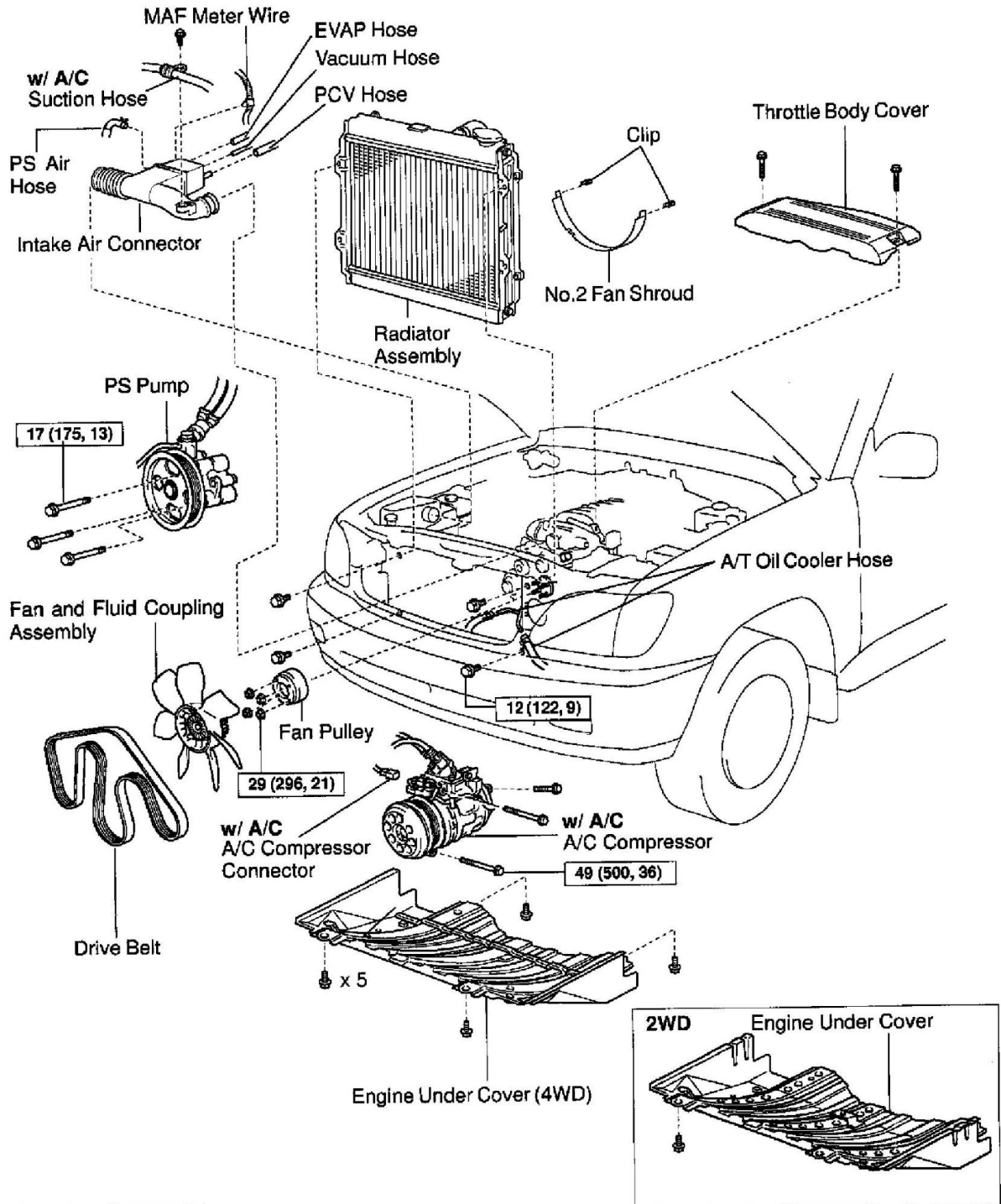

# Toyota Truck Sequoia LTD 2WD V8-4.7L (2UZ-FE) 2002

## Timing Belt: Service and Repair



$\gamma$  N·m (kgf·cm, ft·lbf) : Specified torque

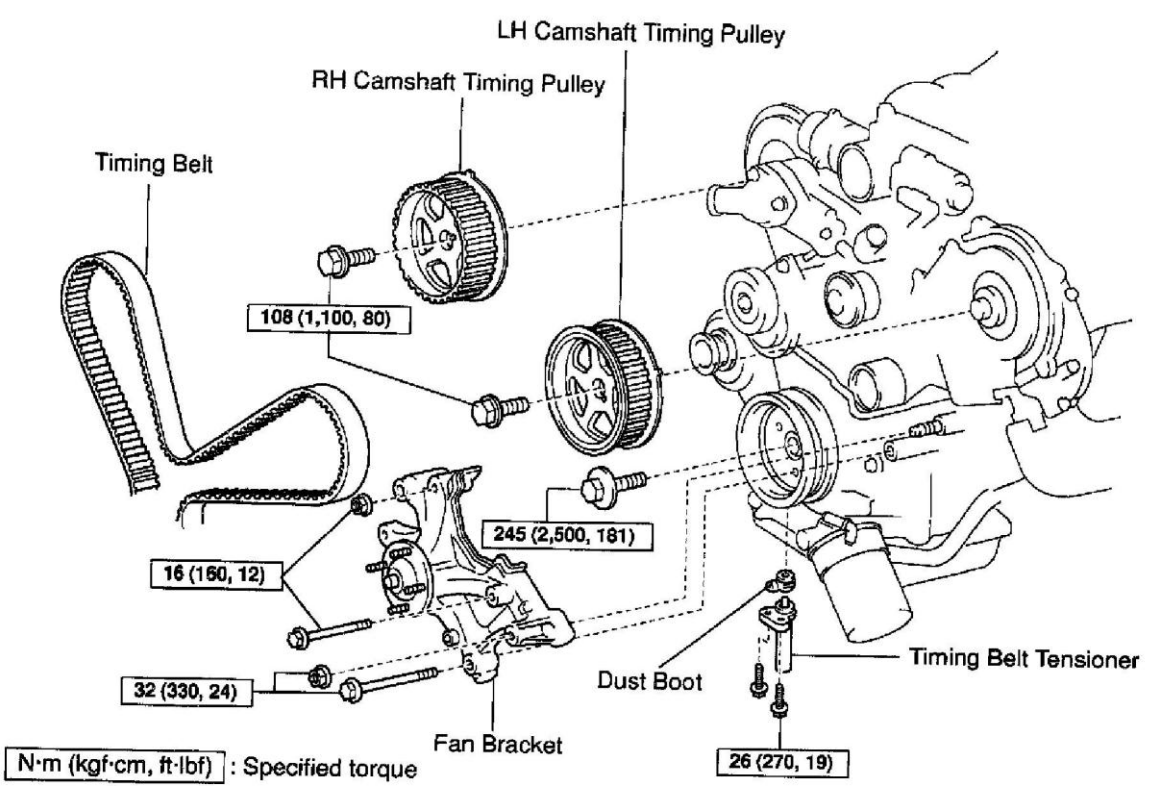
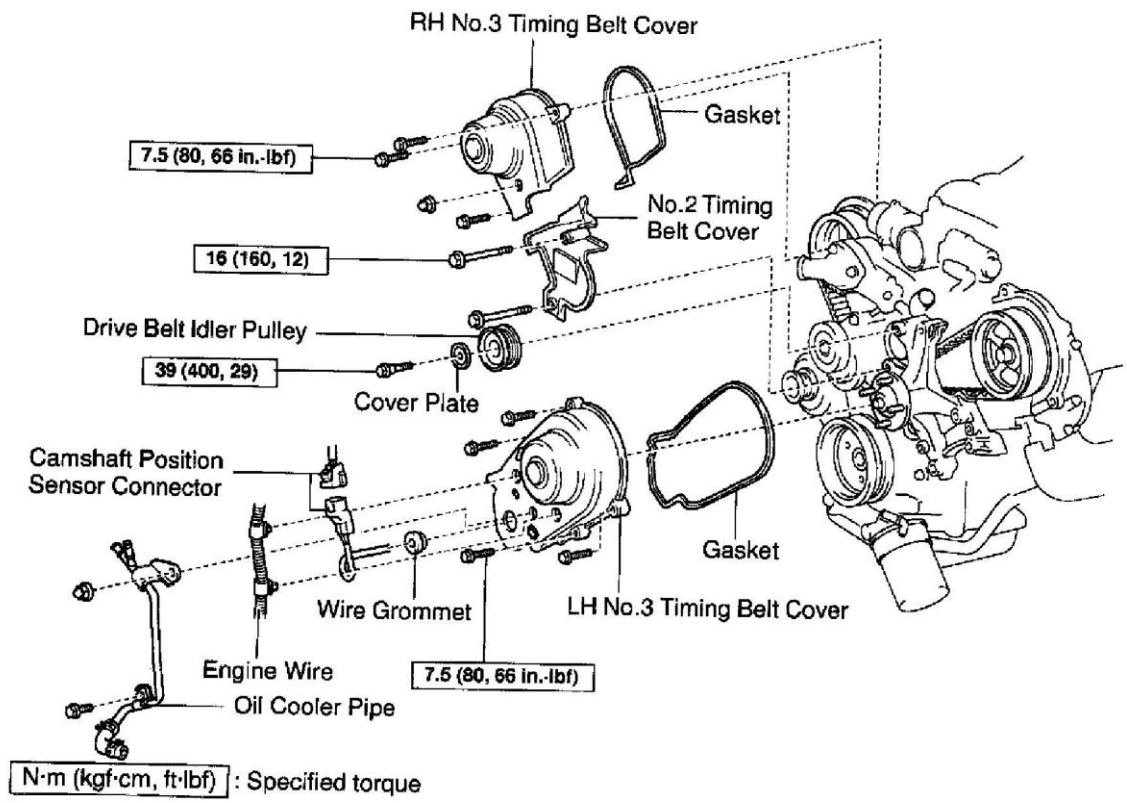

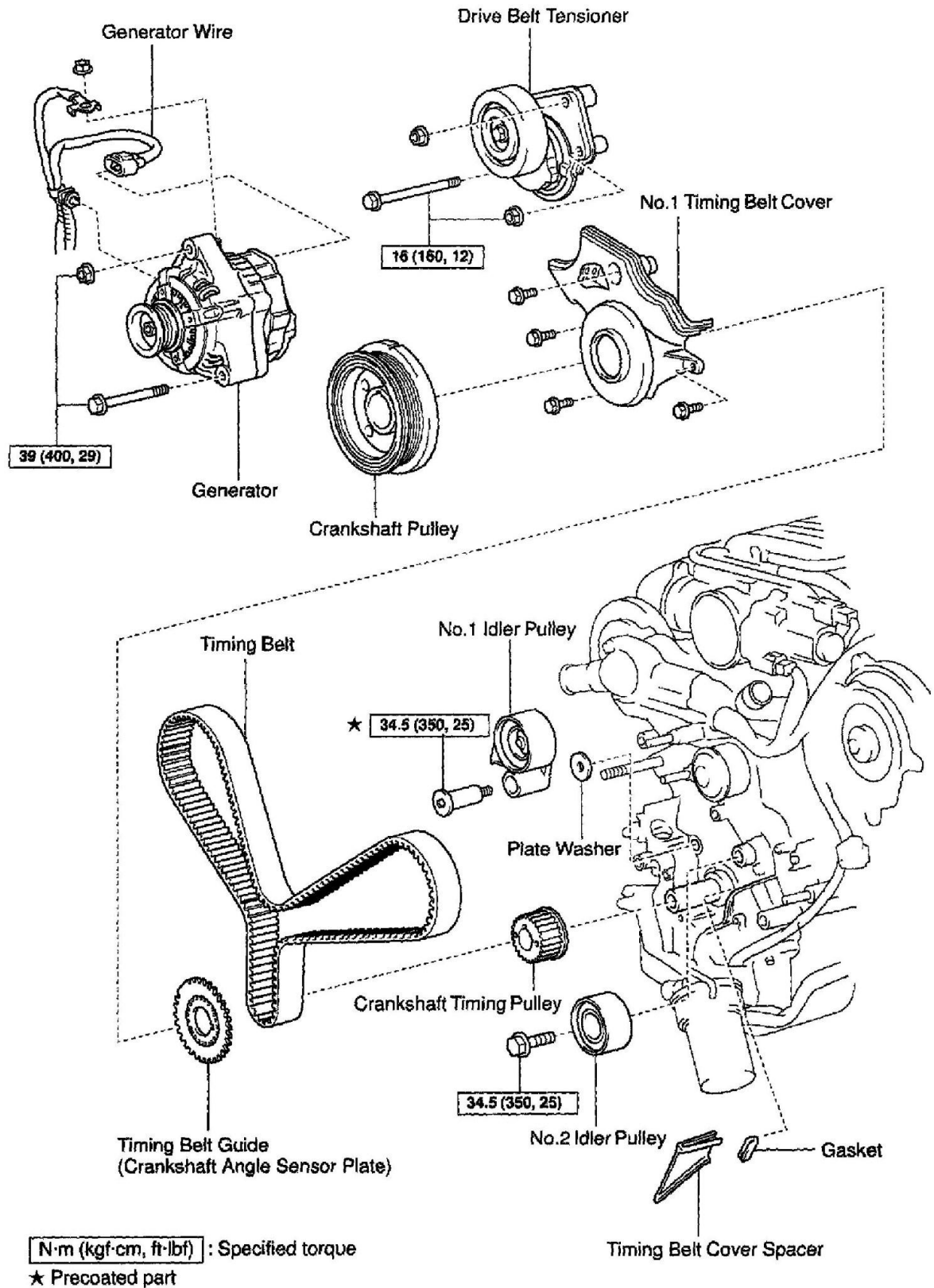

## REMOVAL

1. REMOVE ENGINE UNDER COVER
2. DRAIN ENGINE COOLANT
3. REMOVE RADIATOR ASSEMBLY
4. REMOVE THROTTLE BODY COVER
5. REMOVE INTAKE AIR CONNECTOR ASSEMBLY

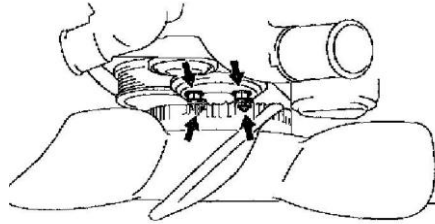

6. REMOVE DRIVE BELT, FAN, FLUID COUPLING AND FAN PULLEY a Loosen the 4 nuts holding the fluid coupling to the fan bracket.  
 b Remove the drive belt.  
 c Remove the 4 nuts, the fan, fluid coupling assembly and fan pulley.

7. DISCONNECT PS PUMP

Remove the 3 bolts, and disconnect the PS pump from the engine.

HINT: Suspend the PS pump securely.

8. REMOVE DRIVE BELT IDLER PULLEY

Remove the pulley bolt, cover plate and idler pulley.

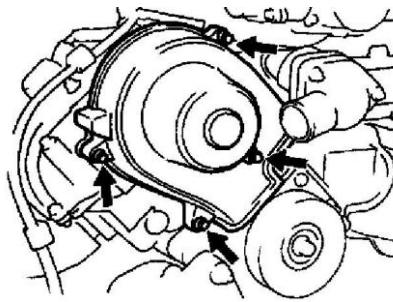

9. REMOVE RH NO.3 TIMING BELT COVER

Remove the 3 bolts, nut and RH No.3 timing belt cover.

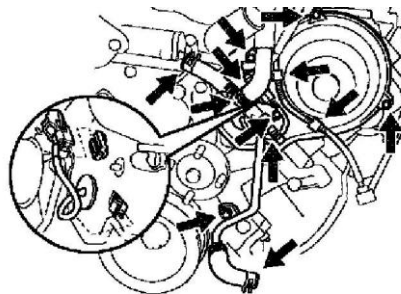

10. REMOVE LH NO.3 TIMING BELT COVER

- a Disconnect the engine wire from the 2 wire clamps. b Remove the 4 bolts and nut. c Disconnect the camshaft position sensor wire from the wire clamp on the LH No.3 timing belt cover. d Disconnect the camshaft position sensor connector from the connector bracket. e Disconnect the camshaft position sensor connector. f Remove the wire grommet from the LH No.3 timing belt cover. g Remove the LH No.3 timing belt cover. h Remove the bolt, nut and oil cooler pipe.

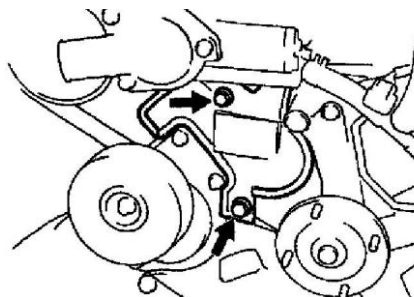

11. REMOVE NO.2 TIMING BELT COVER

Remove the 2 bolts and No.2 timing belt cover.

12. w/ A/C:

DISCONNECT A/C COMPRESSOR FROM ENGINE

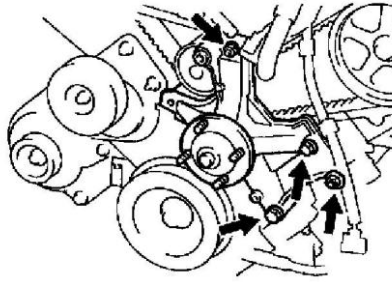

13. REMOVE FAN BRACKET

Remove the 2 bolts, 2 nuts and fan bracket.

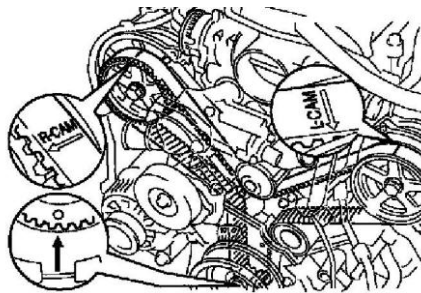

14. IF RE-USING TIMING BELT, CHECK INSTALLATION MARKS ON TIMING BELT

Check that there are 3 installation marks on the timing belt by turning the crankshaft pulley as shown in the illustration.

HINT: If the installation marks have disappeared, place a new installation mark on the timing belt before removing each part.

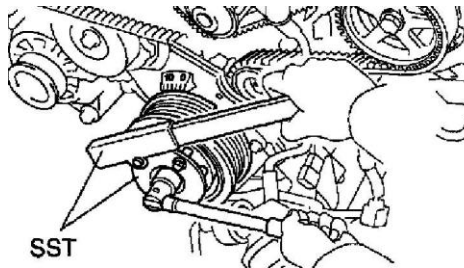

15. LOOSEN CRANKSHAFT PULLEY BOLT

Using SST, loosen the pulley bolt.

SST 09213-70011 (90105-08076), 09330-00021

16. SET NO.1 CYLINDER TO TDC/COMPRESSION

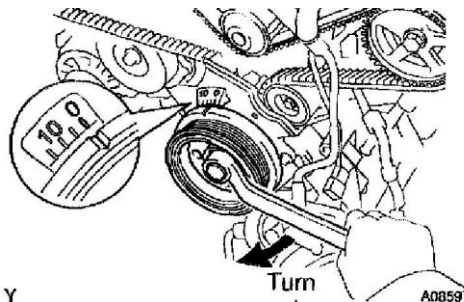

a Turn the crankshaft pulley and align its groove with timing mark "0" of the No.1 timing belt cover.

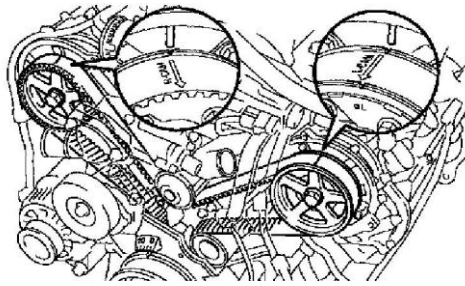

- b Check that the timing marks of the camshaft timing pulleys and timing belt rear plates aligned. If not, turn the crankshaft 1 revolution (360 °). c Remove the crankshaft pulley bolt.

NOTICE: Do not turn the crankshaft pulley.

#### 17. REMOVE TIMING BELT TENSIONER

HINT:

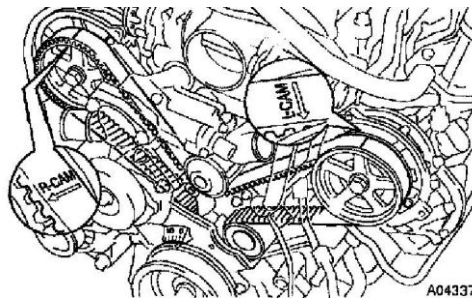

- When re-using timing belt:  
If the installation marks have disappeared, before remove the timing belt, place 2 new installation marks on the timing belt to match the timing marks of the camshaft timing pulleys.

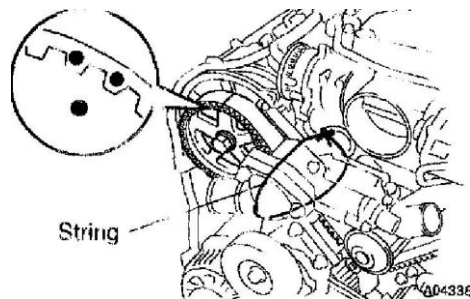

- When replacing timing belt tensioner only:  
To avoid meshing of the timing pulley and timing belt, secure one of them with string. And place matchmarks on the timing belt and RH camshaft timing pulley.

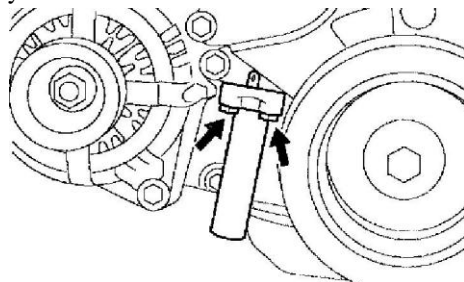

Alternately loosen the 2 bolts, and remove them, the belt tensioner and dust boot.

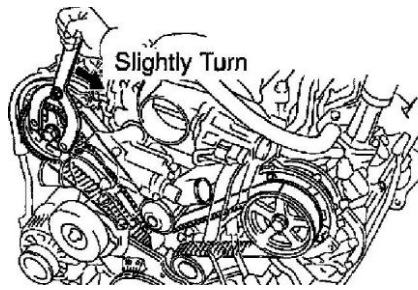

**18. DISCONNECT TIMING BELT FROM CAMSHAFT TIMING PULLEYS**

- a Using SST, loosen the tension splint between the LH and RH camshaft timing pulleys by slightly turning the LH camshaft timing pulley clockwise.

SST 09960-10010 (09962-01000, 09963-01000) b Disconnect the timing belt from the camshaft timing pulleys.

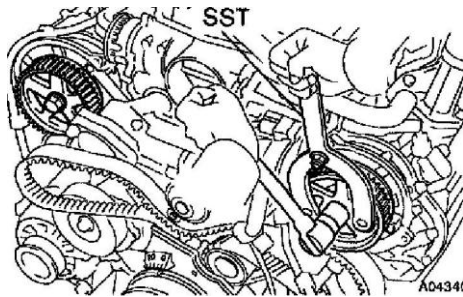

**19. REMOVE CAMSHAFT TIMING PULLEYS**

Using SST, remove the bolt and timing pulley. Remove the 2 timing pulleys. SST 09960-10010 (09962-01000, 09963-01000)

**20. REMOVE GENERATOR**

**21. REMOVE DRIVE BELT TENSIONER**

Remove the bolt, 2 nuts and belt tensioner

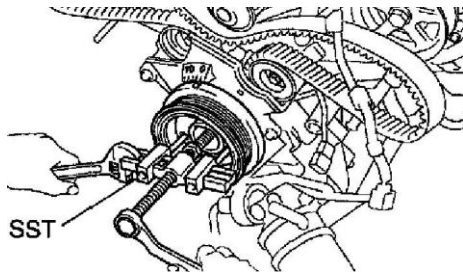

**22. REMOVE CRANKSHAFT PULLEY**

Using SST, remove the crankshaft pulley.

SST 09950-50013 (09951-05010, 09951-05010, 09953-05010, 09953-05020, 09954-05021)

NOTICE: Do not turn the crankshaft pulley.

**23. REMOVE NO.1 TIMING BELT COVER**

Remove the 4 bolts and timing belt cover.

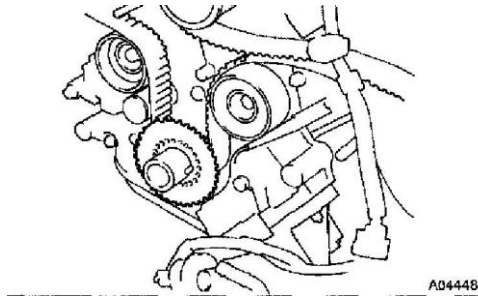

24. REMOVE TIMING BELT GUIDE
25. REMOVE TIMING BELT COVER SPACER

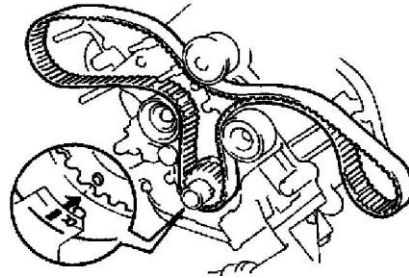

26. REMOVE TIMING BELT

HINT: If re-using the belt and the installation mark has disappeared from it, place a new installation mark on the timing belt to match the dot mark of the crankshaft timing pulley.

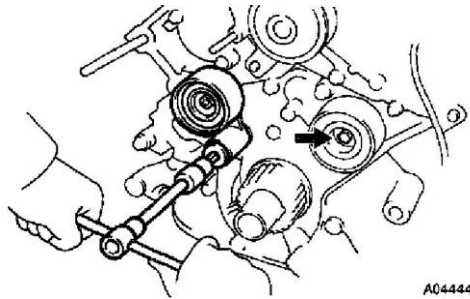

27. REMOVE NO.1 IDLER PULLEY AND NO.2 IDLER PULLEY

- a Using a 10 mm hexagon wrench, remove the bolt, No.1 idler pulley and plate washer. b Remove the bolt and No.2 idler pulley.

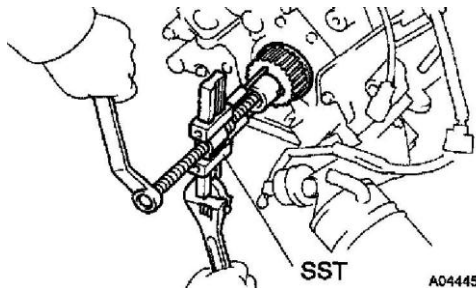

28. REMOVE CRANKSHAFT TIMING PULLEY

Using SST, remove the timing pulley.

SST 09950-50013 (09951-05010, 09952-05010, 09953-05010, 09953-05020, 09954-

05011) NOTICE: Do not turn the timing pulley.

INSPECTION



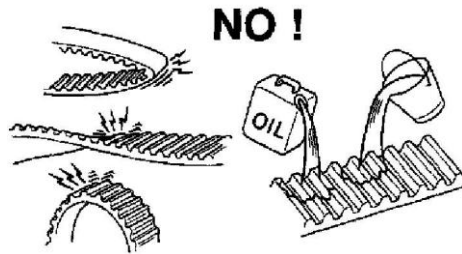

EM3336

## 1. INSPECT TIMING BELT

### NOTICE:

- Do not bend, twist or turn the timing belt inside out.
- Do not allow the timing belt to come into contact with oil, water or steam.
- Do not utilize timing belt tension when installing or removing the mount bolt of the camshaft timing pulley.

If there is any defect, as shown in the illustration, check these points: a Premature parting

- Check for proper installation.
  - Check the timing cover gasket for damage and proper installation.
- b If the belt teeth are cracked or damaged, check to see if either camshaft is locked. c If there is noticeable wear or cracks on the belt face, check to see if there are nicks on the side of the idler pulley lock and water pump. d If there is wear or damage on even one side of the belt, check the belt guide and the alignment of each pulley.
- e If there is noticeable wear on the belt teeth, check timing cover for damage and for foreign material on the pulley teeth. If necessary, replace the timing belt.

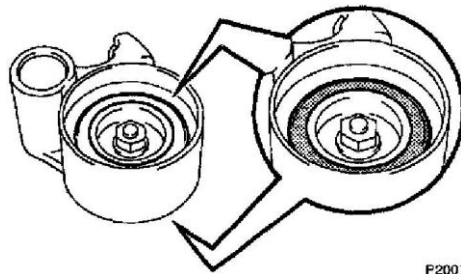

F20079

## 2. INSPECT IDLER PULLEYS

- a Visually check the seal portion of the idler pulley for oil leakage. If leakage is found, replace the idler pulley.
- b Check that the idler pulley turns smoothly. If necessary, replace the idler pulley.

## 3. INSPECT TIMING BELT TENSIONER

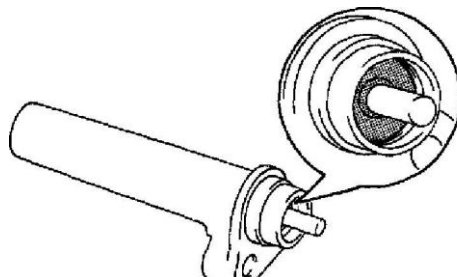

- a Visually check the seal portion of the tensioner for oil leakage.

HINT: If there is only the faintest trace of oil on the seal on the push rod side, the tensioner is all right.

If leakage is found, replace the tensioner.

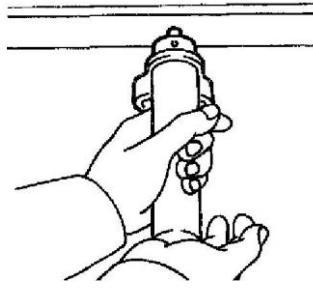

- b Hold the tensioner with both hands and push the push rod strongly as shown to check that it doesn't move. If the push rod moves, replace the tensioner.

NOTICE: Never hold the tensioner push rod facing downward.

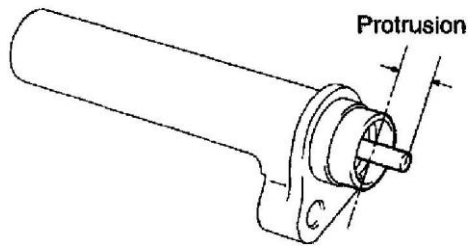

- c Measure the protrusion of the push rod from the housing end.  
 Protrusion: 10.5 - 11.5 mm (0.413 - 0.453 inch)  
 If the protrusion is not as specified, replace the tensioner.

#### 4. INSPECT WATER PUMP

#### INSTALLATION

##### 1. INSTALL CRANKSHAFT TIMING PULLEY

- a Align the timing pulley set key with the key groove of the pulley.

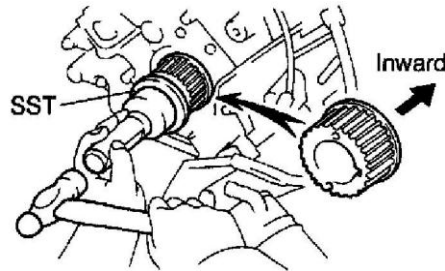

- b Using SST and a hammer, tap in the timing pulley, facing the flange side inward. SST 09223-46011

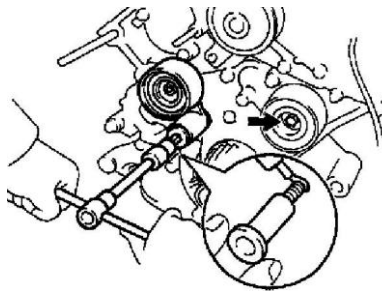

- 2. INSTALL NO.1 IDLER PULLEY AND NO.2 IDLER PULLEY a Apply adhesive 2 or 3 threads of the pivot bolt.

Adhesive: Part No. 08833-00080, THREE BOND 1344, LOCTITE 242 or equivalent b Using a 10 mm hexagon wrench, install the plate washer and No.1 idler pulley with the pivot bolt.

Torque: 34.5 Nm (350 kgf-cm, 25 ft. lbs.) c Install the No.2 idler pulley with the bolt.

Torque: 34.5 Nm (350 kgf-cm, 25 ft. lbs.)

d Check that the No.1 and No.2 idler pulleys moves smoothly.

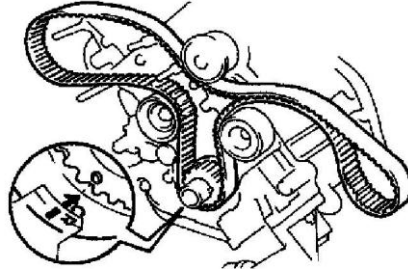

### 3. TEMPORARILY INSTALL TIMING BELT

NOTICE: The engine should be cold.

a Remove any oil or water on the crankshaft pulley, oil pump pulley, water pump pulley, No.1 idler pulley and No.2 idler pulley, and keep them clean.

NOTICE: Only wipe the pulleys; do not use any cleansing agent.

b Align the installation mark on the timing belt with the timing mark of the crankshaft timing pulley.

c Install the timing belt on the crankshaft timing pulley, No.1 idler pulley and No.2 idler pulley.

4. INSTALL TIMING BELT COVER SPACER a Install the gasket to the cover spacer. b Install the cover spacer.

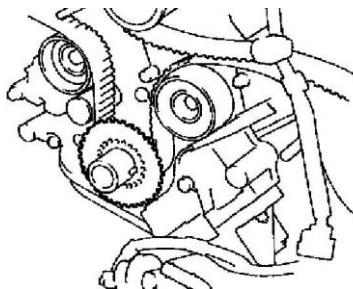

### 5. INSTALL TIMING BELT GUIDE

Install the belt guide, facing the cup side outward.

### 6. INSTALL NO.1 TIMING BELT COVER

Install the timing belt cover with the 4 bolts.

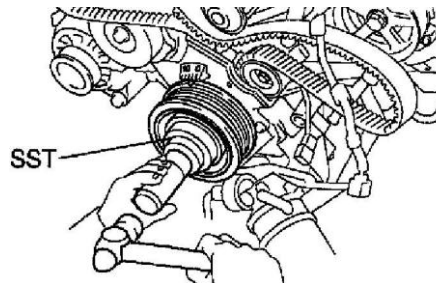

### 7. INSTALL CRANKSHAFT PULLEY

a Align the pulley set key with the key groove of the crankshaft pulley.

b Using SST and a hammer, tap in the crankshaft pulley. SST 09223-46011

8. INSTALL DRIVE BELT TENSIONER

Install the belt tensioner with the bolt and 2 nuts. Torque: 16 Nm (160 kgf-cm, 12 ft. lbs.)

HINT: Use a bolt 106 mm (4.18 inch) in length.

9. INSTALL GENERATOR

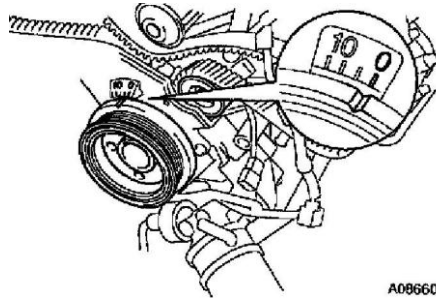

10. CHECK CRANKSHAFT PULLEY POSITION

Check that the timing mark of the crankshaft pulley is aligned with timing mark "0" of the No.1 timing belt cover.

11. INSTALL RH, LH CAMSHAFT TIMING PULLEYS

a Align the camshaft knock pin with the knock pin groove of the timing pulley, and slide on the timing pulley.

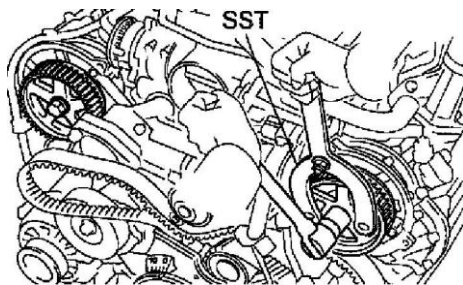

b Using SST, install the pulley bolt.

SST 09960-10010 (09962-01000, 09963-01000)

Torque: 108 Nm (1,100 kgf-cm, 80 ft. lbs.)

12. CONNECT TIMING BELT TO LH CAMSHAFT TIMING PULLEY

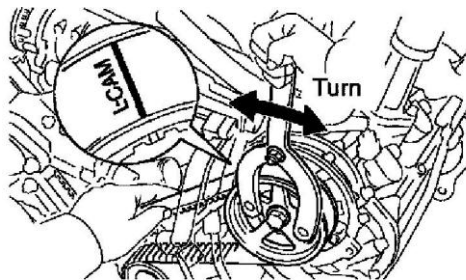

a Remove any oil or water on the LH camshaft timing pulley, and keep it clean.

NOTICE: Only wipe the pulleys; do not use any cleansing agent.

b Turn the LH camshaft timing pulley. Align the installation mark on the timing belt with the timing mark of the camshaft timing pulley, and hang the timing belt on the LH camshaft timing pulley.

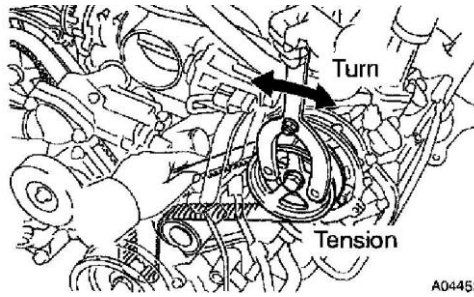

- c Turn the LH camshaft timing pulley counterclockwise until there is tension between the crankshaft timing pulley and LH camshaft timing pulley.

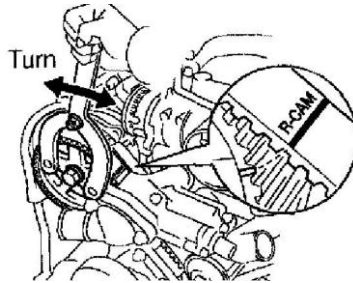

13. CONNECT TIMING BELT TO RH CAMSHAFT TIMING PULLEY

- a Remove any oil or water on the RH camshaft timing pulley and water pump pulley, and keep them clean.

NOTICE: Only wipe the pulleys; do not use any cleansing agent.

- b Turn the RH camshaft timing pulley. Align the installation mark on the timing belt with the timing mark of the camshaft timing pulley, and hang the timing belt on the RH camshaft timing pulley.

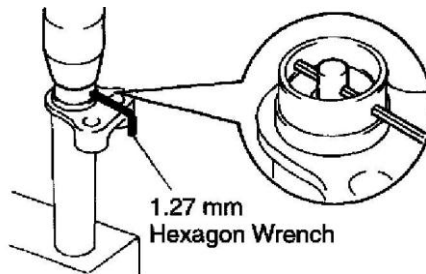

14. SET TIMING BELT TENSIONER

- a Using a press, slowly press in the push rod using 981 - 9,807 N (100 - 1,000 kgf, 220 - 2,205 lbs.) of pressure. b Align the holes of the push rod and housing, pass a 1.27 mm hexagon wrench through the holes to keep the setting position of the push rod. c Release the press. d Install the dust boot to the belt tensioner.

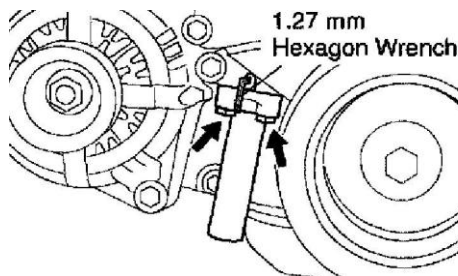

15. INSTALL TIMING BELT TENSIONER

- a Temporarily install the belt tensioner with the 2 bolts.  
 b Alternately tighten the 2 bolts.  
 Torque: 26 Nm (270 kgf-cm, 19 ft. lbs.)  
 c Using pliers, remove the 1.27 mm hexagon wrench from the belt tensioner.

16. CHECK VALVE TIMING

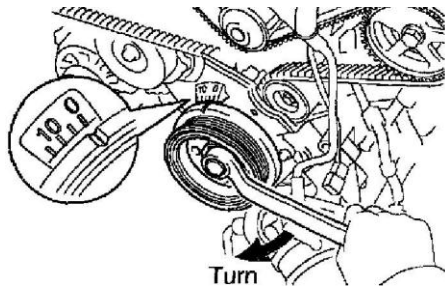

- a Temporarily install the crankshaft pulley bolt. b Slowly turn the crankshaft pulley 2 revolutions from TDC to TDC.

NOTICE: Always turn the crankshaft pulley clockwise.

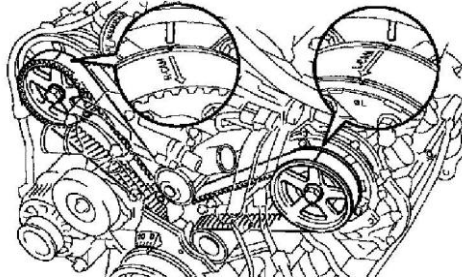

- c Check that each pulley aligns with the timing marks as shown in the illustration. If the timing marks do not align, remove the timing belt and reinstall it.

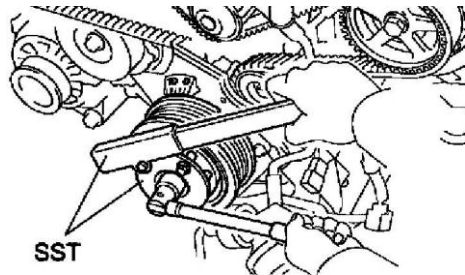

#### 17. TIGHTEN CRANKSHAFT PULLEY BOLT

Using SST, install the pulley bolt.

SST 09213-70011 (90119-08216), 09330-00021

Torque: 245 Nm (2,500 kgf-cm, 181 ft. lbs.)

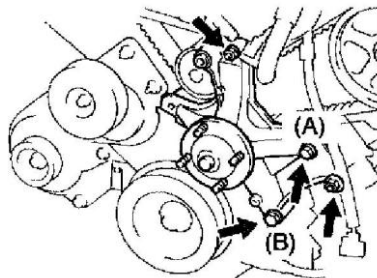

#### 18. INSTALL FAN BRACKET

Install the fan bracket with the 2 bolts and 2 nuts.

Torque:

12 mm head 16 Nm (160 kgf-cm, 12 ft.

lbs.) for (A) 14 mm head 32 Nm (330 kgf-

cm, 24 ft. lbs.) for (B)

HINT: Each bolt length is indicated in the illustration.

Bolt Length: 106 mm (4.17 inch) for 12 mm head (A)

114 mm (4.49 inch) for 14 mm head (B)

19. w A/C:

**INSTALL A/C COMPRESSOR**

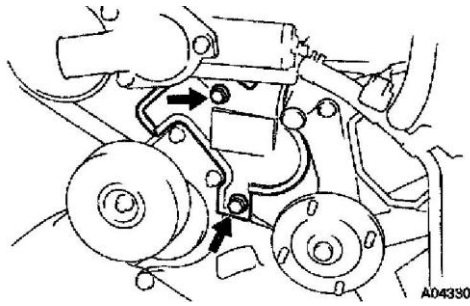

**20. INSTALL NO.2 TIMING BELT COVER**

Install the No.2 timing belt cover with the 2 bolts.

Torque: 16 Nm (160 kgf-cm, 12 ft. lbs.)

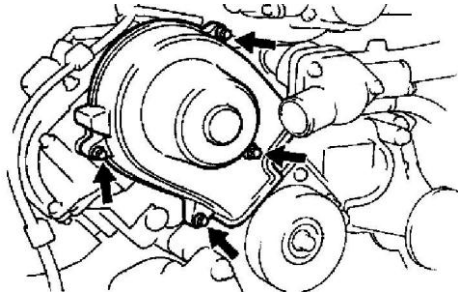

**21. INSTALL RH NO.3 TIMING BELT COVER**

a Fit the RH No.3 timing belt cover, matching it with the fan bracket.

b Install the RH No.3 timing belt cover with the 3 bolts and nut. Torque: 7.5 Nm (80 kgf-cm, 66 inch lbs.)

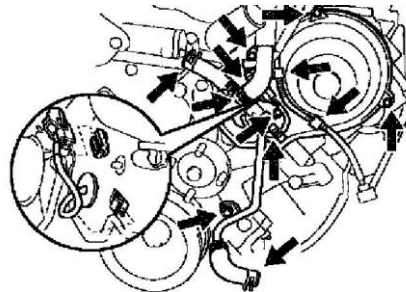

**22. INSTALL LH NO.3 TIMING BELT COVER**

a Install the oil cooler pipe with the bolt and nut. b Run the camshaft position sensor wire through the LH No.3 timing belt cover hole. c Fit the LH No.3 timing belt cover, matching it with the fan bracket.

d Install the LH No.3 timing belt cover with the 4 bolts and nut.

Torque: 7.5 Nm (80 kgf-cm, 66 inch lbs.) e

Install the wire grommet to the LH No.3 timing belt cover. f Install the camshaft position sensor connector to the connector bracket.

g Connect the camshaft position sensor connector. h Install the sensor wire to the wire clamp on the LH No.3 timing belt cover.

i Install the engine wire to the 2 wire clamps on the LH No.3 timing belt cover.

**23. INSTALL DRIVE BELT IDLER PULLEY**

Install the idler pulley and cover plate with the bolt.

Torque: 39 Nm (400 kgf-cm, 29 ft. lbs.)

**24. INSTALL PS PUMP**

Install the PS pump with the 3 bolts.  
Torque: 17 Nm (175 kgf-cm, 13 ft. lbs.)

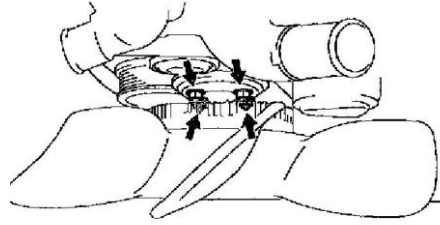

25. INSTALL FAN PULLEY, FAN, FLUID COUPLING AND DRIVE BELT
  - a Temporarily install the fan pulley, the fan, fluid coupling assembly with the 4 nuts. b Install the drive belt.
  - c Tighten the 4 nuts holding the fluid coupling to the fan bracket.  
Torque: 29 Nm (296 kgf-cm, 21 ft. lbs.)
26. INTAKE AIR CONNECTOR ASSEMBLY
27. INSTALL THROTTLE BODY COVER
28. INSTALL RADIATOR ASSEMBLY
29. FILL WITH ENGINE COOLANT
30. START ENGINE AND CHECK FOR LEAKS
31. RECHECK ENGINE COOLANT LEVEL
32. INSTALL ENGINE UNDER COVER