

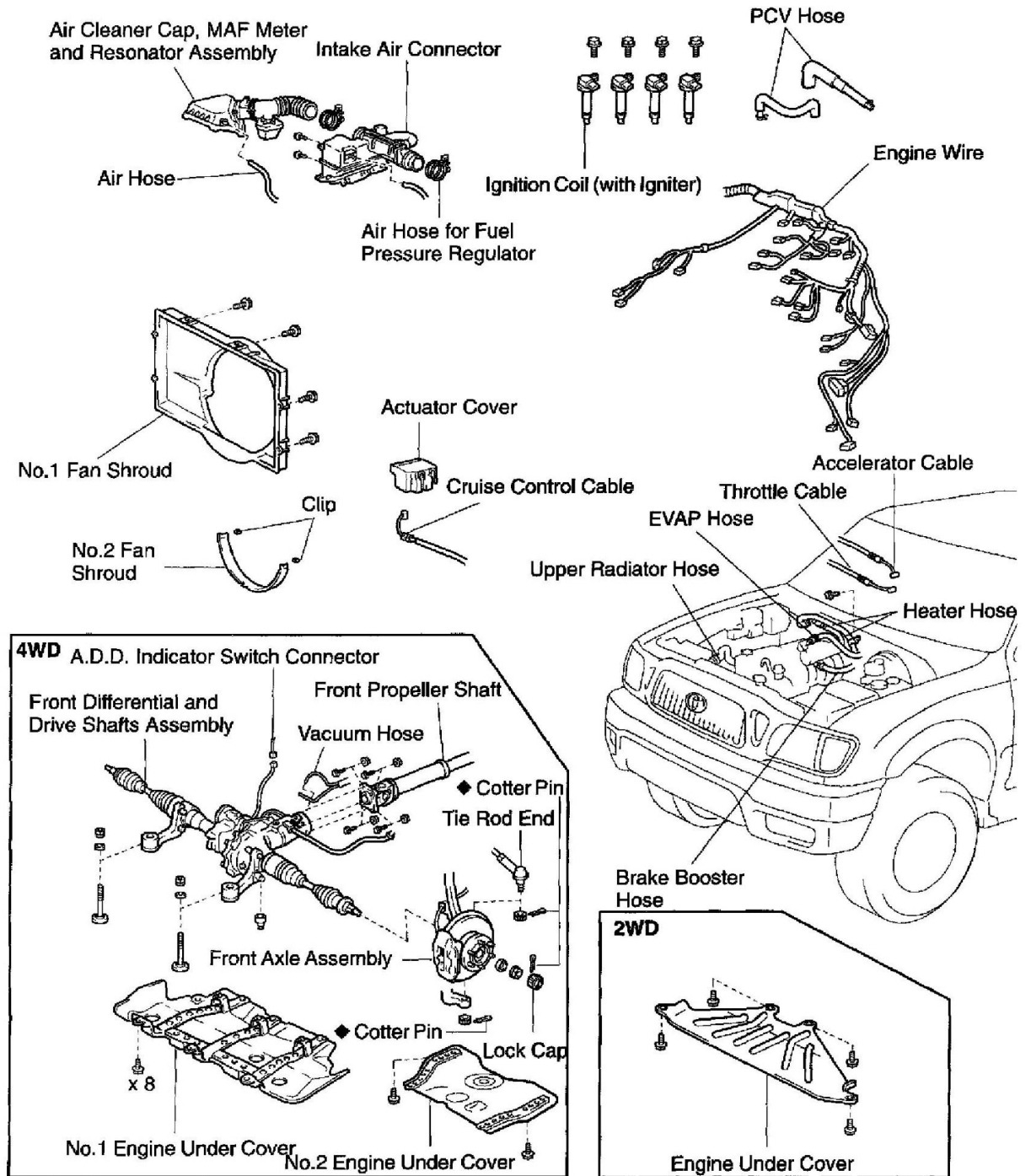

Toyota Truck Tacoma Extra Cab 2WD L4-2.4L (2RZ-FE) 2002

Timing Chain: Service and Repair



◆ Non-reusable part

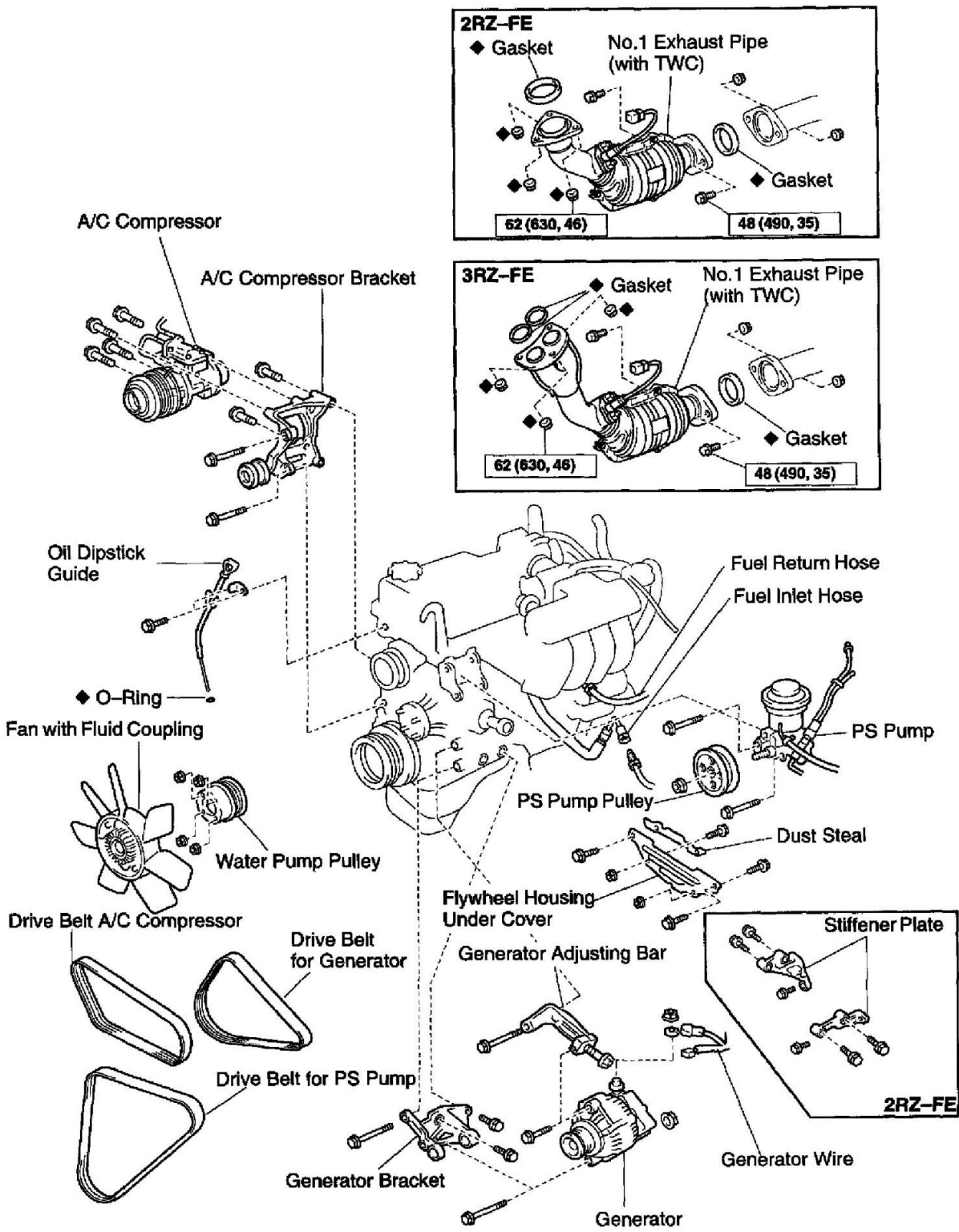

N·m (kgf·cm, ft·lbf) : Specified torque
◆ Non-reusable part

for 2RZ-FE

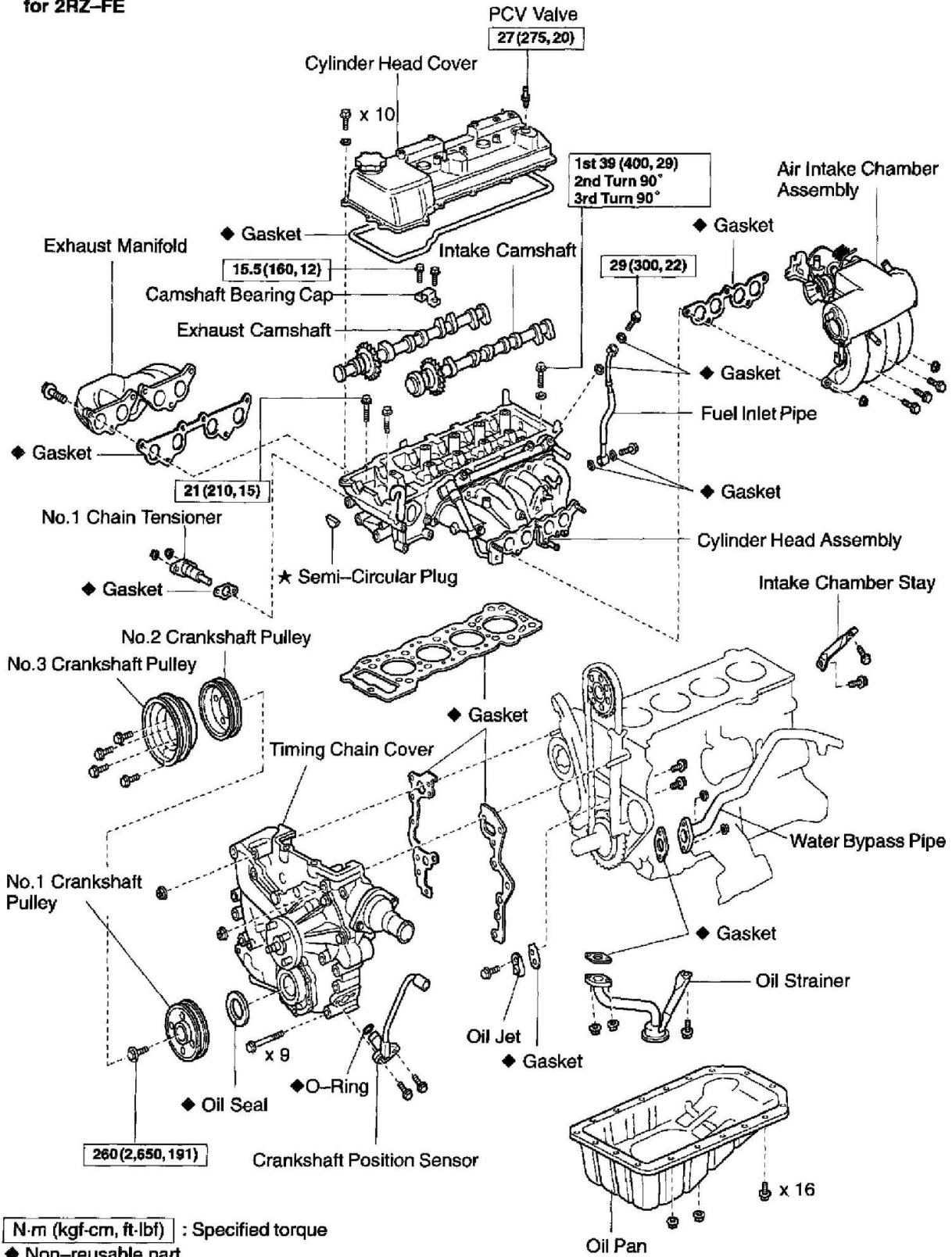

N·m (kgf·cm, ft·lbf) : Specified torque

◆ Non-reusable part

★ Precoated part

for 3RZ-FE

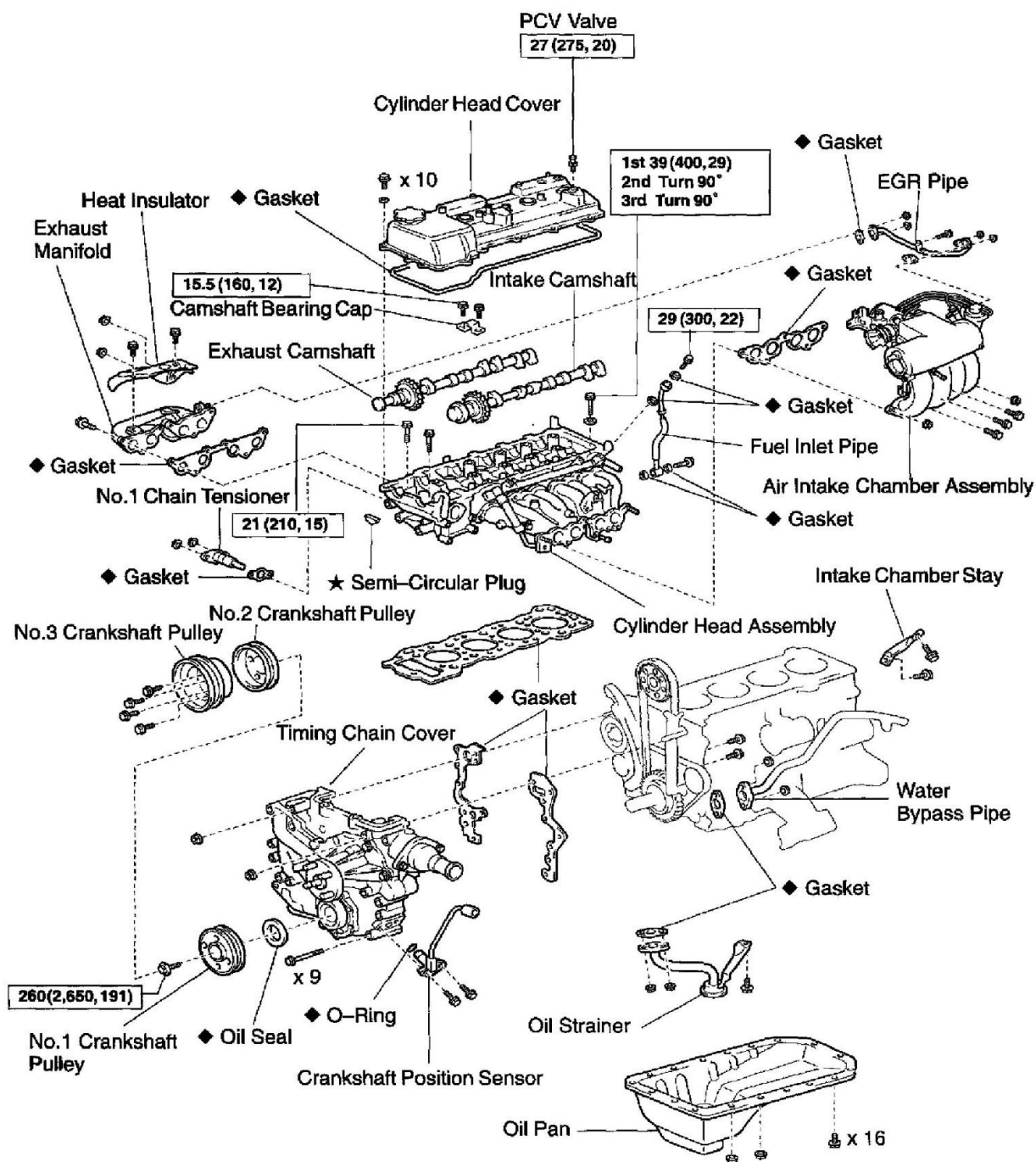

^P N·m (kgf·cm, ft·lbf) : Specified torque

◆ Non-reusable part

★ Precoated part

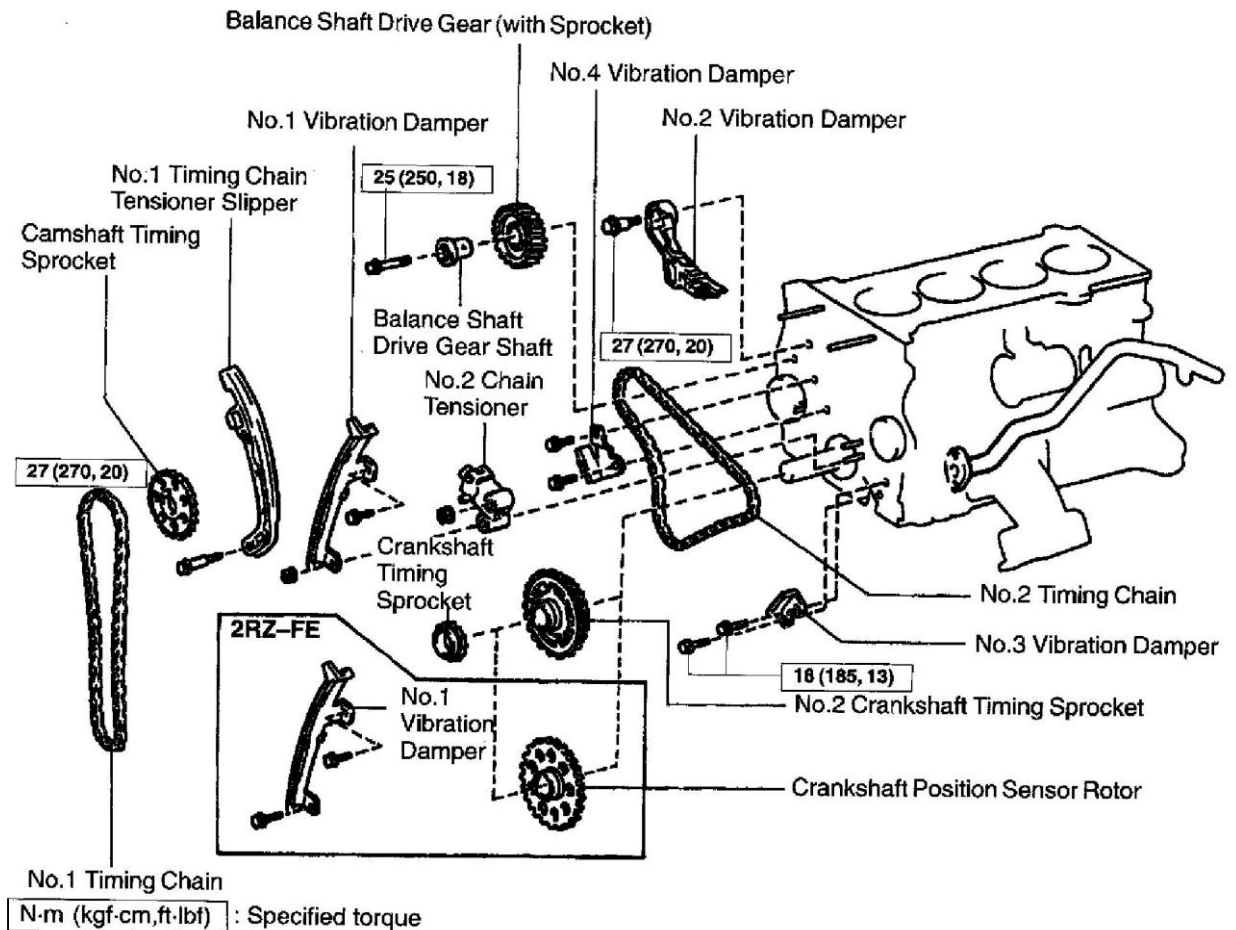

REMOVAL

1. REMOVE ENGINE UNDER COVER
2. DRAIN ENGINE OIL
3. 4 WD: REMOVE FRONT DIFFERENTIAL AND DRIVE SHAFTS ASSEMBLY
4. REMOVE DRIVE BELT FOR GENERATOR, FAN WITH FLUID COUPLING AND WATER PUMP PULLEY
5. REMOVE CYLINDER HEAD ASSEMBLY
6. DISCONNECT A/C COMPRESSOR AND BRACKET

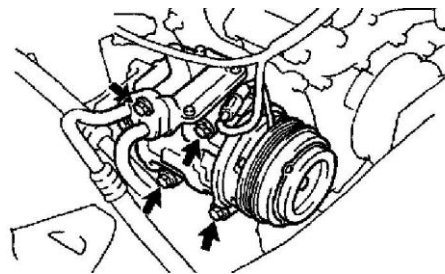

- a. Remove the 4 bolts, and disconnect the compressor from the bracket.

HINT: Put aside the compressor, and suspend it.

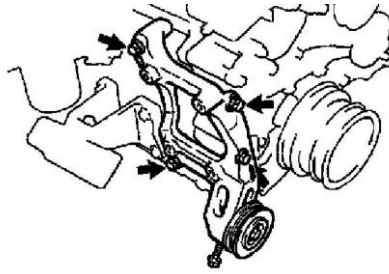

b. Remove the 4 bolts and A/C compressor bracket.

7. REMOVE GENERATOR, ADJUSTING BAR AND BRACKET

a. Disconnect the generator connector.

b. Remove the nut, and disconnect the generator wire and wire clip.

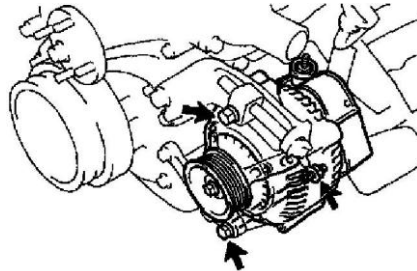

c. Remove the lock bolt, pivot bolt and generator.

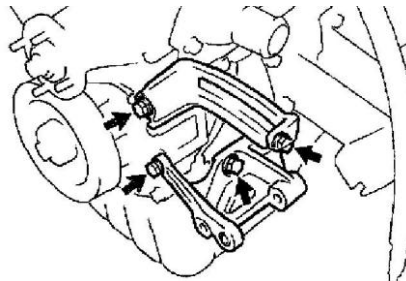

d. Remove the bolt and adjusting bar.

e. Remove the 3 bolts and generator bracket.

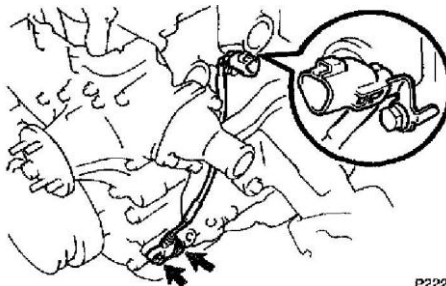

P22208

8. REMOVE CRANKSHAFT POSITION SENSOR

a. Remove the 2 bolts and crankshaft position sensor.

b. Remove the O-ring from the crankshaft position sensor.

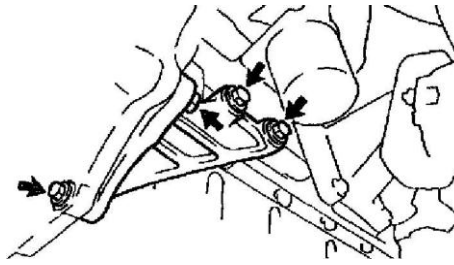

9. 2 WD: REMOVE STIFFENER PLATES

Remove the 8 bolts and stiffener plates.

10. REMOVE FLYWHEEL HOUSING UNDERCOVER AND DUST SEAL

11. REMOVE OIL PAN

a. Remove the 16 bolts and 2 nuts.

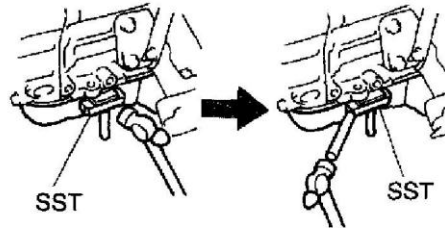

b. Insert the blade of SST between the cylinder block and oil pan, cut off applied sealer and remove the oil pan.

SST 09032-00100

NOTICE: Be careful not to damage the oil pan flanges of the oil pan and cylinder block.

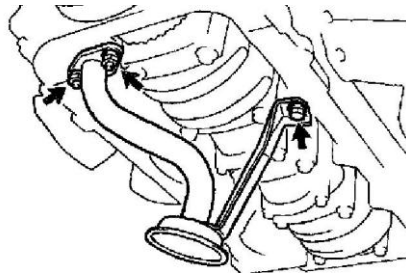

12. REMOVE OIL STRAINER

Remove the bolt, 2 nuts, oil strainer and gasket.

13. REMOVE CRANKSHAFT PULLEY

a. w/ A/C: Remove the 4 bolts, No.2 and No.3 crankshaft pulleys.

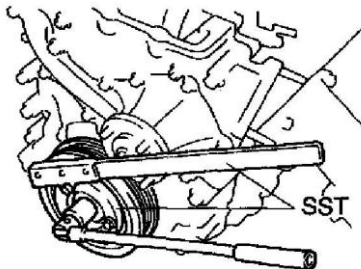

b. Using SST, remove the pulley bolt.

SST 09213-54015, 09330-00021

c. Remove the crankshaft pulley.

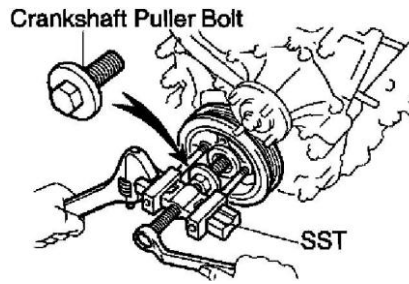

HINT: If necessary, remove the pulley with SST and crankshaft pulley bolt.

SST 09950-50013 (09951-05010, 09952-05010, 09953-05010, 09954-05020)

14. REMOVE TIMING CHAIN COVER

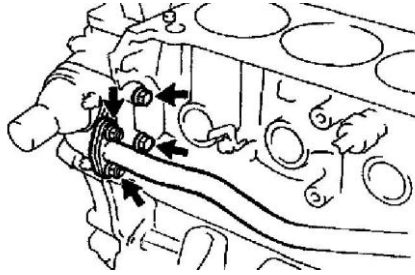

- a. Remove the 2 water bypass pipe nuts.
- b. Remove the 2 timing chain cover bolts.

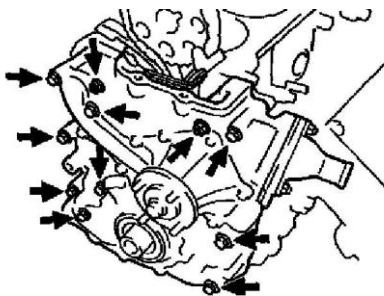

- c. Remove the 9 bolts and 2 nuts.
- d. Using a plastic faced hammer, loosen the chain cover and remove the timing chain cover and 3 gaskets.

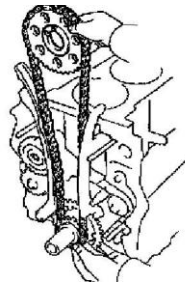

15. REMOVE NO.1 TIMING CHAIN AND CAMSHAFT TIMING SPROCKET

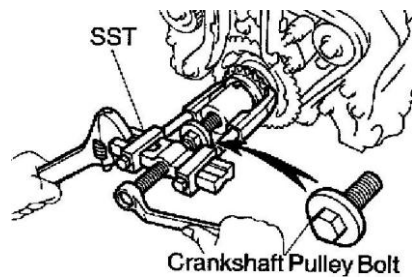

16. REMOVE CRANKSHAFT TIMING SPROCKET HINT.

If necessary, remove the sprocket with SST and crankshaft pulley bolt.

SST 09950-40011 (09951-04010, 09952-04010, 09953-04010, 09954-04010, 09955-04061)

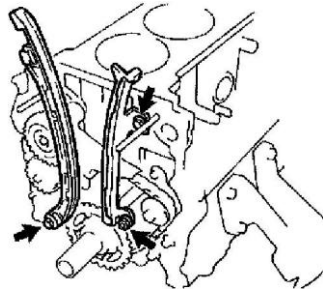

17. REMOVE NO.1 TIMING CHAIN TENSIONER SLIPPER AND NO.1 VIBRATION DAMPER a. Remove the bolt and slipper.

b. 2 RZ-FE: Remove the 2 bolts and No.1 damper.

c. 3 RZ-FE: Remove the bolt, nut and No.1 damper.

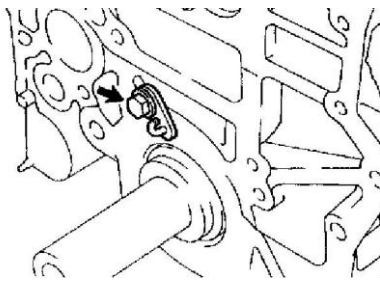

18. 2 RZ-FE: REMOVE CRANKSHAFT POSITION SENSOR ROTOR

19. 2 RZ-FE: REMOVE TIMING CHAIN OIL JET

Remove the bolt, oil jet and gasket.

20. 3RZ-FE: REMOVE NO.2, NO.3 VIBRATION DAMPERS AND NO.2 CHAIN TENSIONER

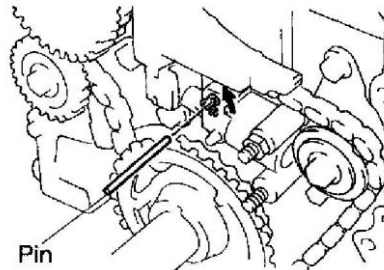

a. Install a pin to the No.2 chain tensioner and lock the plunger.

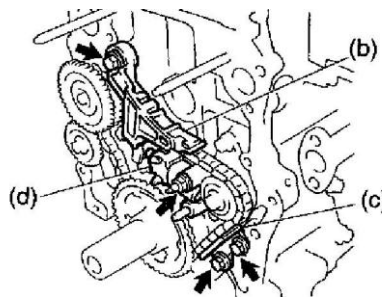

b. Remove the bolt and No.2 damper.

c. Remove the 2 bolts and No.3 damper.

d. Remove the nut and No.2 chain tensioner.

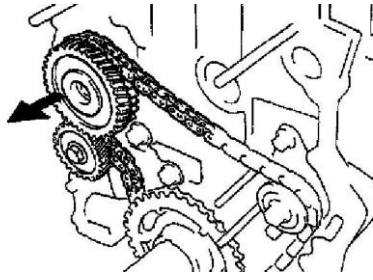

21. 3 RZ-FE: REMOVE BALANCE SHAFT DRIVE GEAR, SHAFT, NO.2 TIMING CHAIN AND NO.2 CRANKSHAFT TIMING SPROCKET
- Remove the bolt from the balance shaft drive gear.
 - Remove the balance shaft drive gear with the shaft.
 - Remove the No.2 timing chain with the No.2 crankshaft timing sprocket.

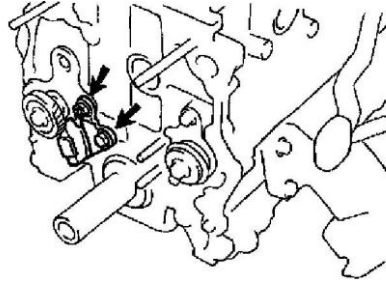

22. 3 RZ-FE: REMOVE NO.4 VIBRATION DAMPER
Remove the 2 bolts and No.4 damper.

INSPECTION

1. INSPECT TIMING CHAINS AND SPROCKETS

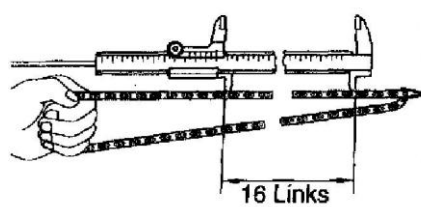

- Measure the length of the 16 links with the chain fully stretched.

No.1 timing chain	147.5 mm (5.807 in.)
No.2 timing chain (3RZ-FE)	123.6 mm (4.866 in.)

Maximum chain elongation

If the elongation is greater than maximum, replace the chain.

HINT: Make the same measurements pulling at 3 or more places selected at random.

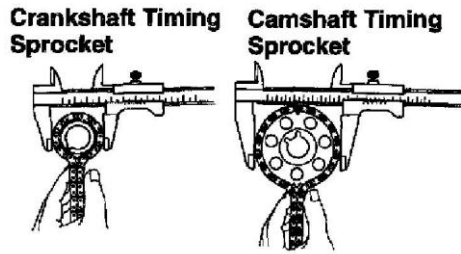

3RZ-FE

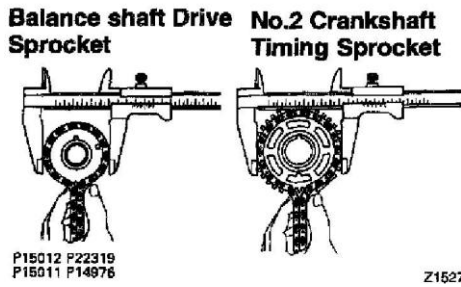

- b. Wrap the chain around the timing sprocket.
- c. Using vernier calipers, measure the sprocket diameter with the chain.

NOTICE: Vernier calipers must contact the chain rollers for measuring.

Camshaft	113.8 mm (4.480 in.)
Crankshaft	59.4 mm (2.339 in.)
No.2 crankshaft (3RZ-FE)	96.7 mm (3.807 in.)
Balance shaft (3RZ-FE)	75.9 mm (2.988 in.)

Minimum sprocket diameter with chain

If the diameter is less than minimum, replace the chain with the sprocket.

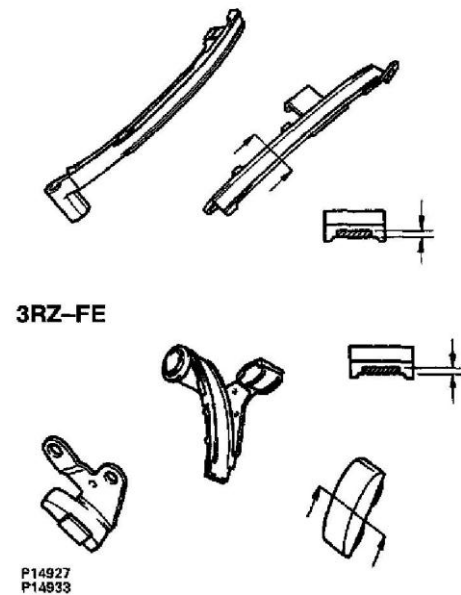

2. INSPECT CHAIN TENSIONER SLIPPER AND VIBRATION DAMPERS

Measure the chain tensioner slipper and vibration damper wears.

Maximum wear: 1.0 mm (0.039 inch)

If the wear is greater than maximum, replace the slipper and/or dampers.

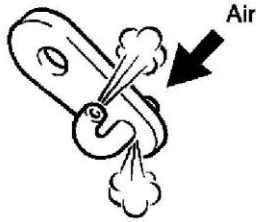

4. 2RZ-FE: INSPECT OIL JET

Check the oil jet for damage or clogging. If necessary, replace the oil jet.

4. INSPECT NO.1 CHAIN TENSIONER

5. 3 RZ-FE: INSPECT NO.2 CHAIN TENSIONER

a. Inspect the chain tensioner.

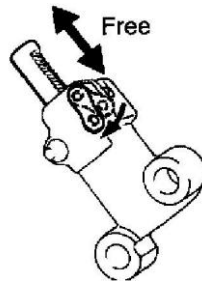

1. Check that the plunger moves smoothly when the ratchet pawl is raised with your finger.

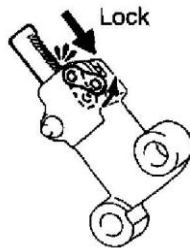

2. Release the ratchet pawl and check that the plunger is locked in place by the ratchet pawl and does not move when pushed with your finger.

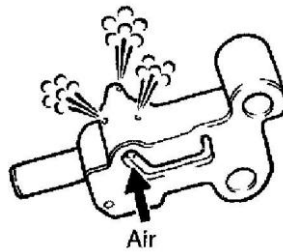

- b. Inspect the oil jet (No.2 chain tensioner). Check the oil jet for damage or clogging.

If necessary, replace the oil jet (No.2 chain tensioner).

INSTALLATION

NOTICE: Check that No.1 cylinder is at TDC and that the weights of the No.1 and No.2 balance shafts are at the bottom side.

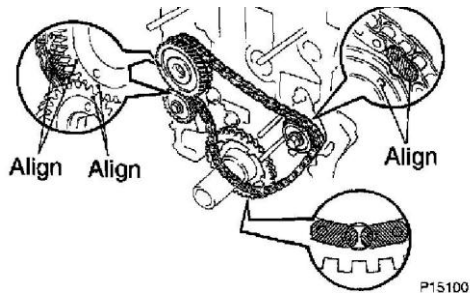

1. INSTALL NO.4 VIBRATION DAMPER

Install the No.4 damper with the 2 bolts.

2. 3 RZ-FE: INSTALL NO.2 TIMING CHAIN, NO.2 CRANKSHAFT TIMING SPROCKET, BALANCE SHAFT DRIVE GEAR AND SHAFT

- a. Install the No.2 timing chain by matching its mark links with the timing marks on the No.2 crankshaft timing sprocket and balance shaft timing sprocket.
- b. Fit the other mark link of No.2 timing chain onto the sprocket behind the large timing mark of the balance shaft drive gear.
- c. Insert the balance shaft drive gear shaft through the balance shaft drive gear so that it fits into the thrust plate hole.
Then align the small timing mark of the balance shaft drive gear with the timing mark of the balance shaft timing gear.
- d. Install the bolt to the balance shaft drive gear and tighten it.

Torque: 25 Nm (250 kgf-cm, 18 ft. lbs.)

- e. Check that each timing mark is matched with the corresponding mark link.

3. 3 RZ-FE: INSTALL NO.2, NO.3 VIBRATION DAMPERS AND NO.2 CHAIN TENSIONER

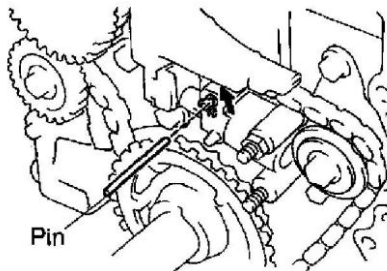

NOTICE:

- Assemble the chain tensioner with the pin installed, then remove the pin after assembly.
- When doing this, avoid pushing the No.2 vibration damper against the chain.

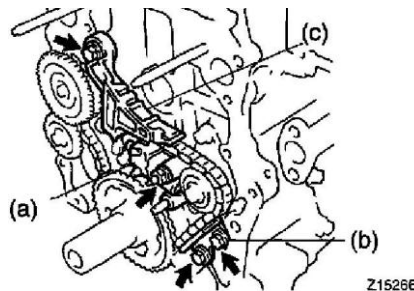

- a. Install the No.2 chain tensioner with the nut.
Torque: 18 Nm (185 kgf-cm, 13 ft. lbs.)
- b. Install No.3 damper with the 2 bolts.
Torque: 18 Nm (185 kgf-cm, 13 ft. lbs.)
- c. Install No.2 damper with the bolt.
Torque: 27 Nm (270 kgf-cm, 20 ft. lbs.)
- d. Remove a pin from the No.2 chain tensioner and free the plunger.

4. 2 RZ-FE: INSTALL OIL JET

Install a new gasket and the oil jet with the bolt.

Torque: 18 Nm (185 kgf-cm, 13 ft. lbs.)

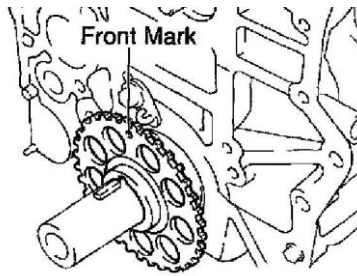

5. 2 RZ-FE: INSTALL CRANKSHAFT POSITION SENSOR ROTOR

Install the rotor to the crankshaft with the front mark (cavity) of the rotor facing forward.

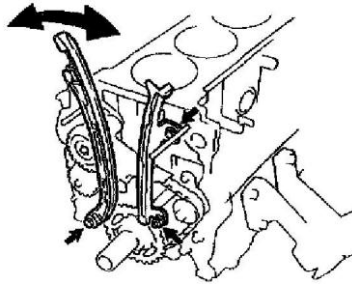

6. INSTALL NO.1 TIMING CHAIN TENSIONER SLIPPER AND NO.1 VIBRATION DAMPER

- a. Install the No.1 damper with the bolt and nut.
Torque: 29 Nm (300 kgf-cm, 22 ft. lbs.)
- b. Install the slipper with the bolt.
Torque: 27 Nm (270 kgf-cm, 20 ft. lbs.)
- c. Check that the slipper moves smoothly.

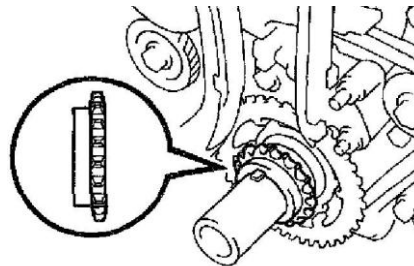

7. INSTALL CRANKSHAFT TIMING SPROCKET

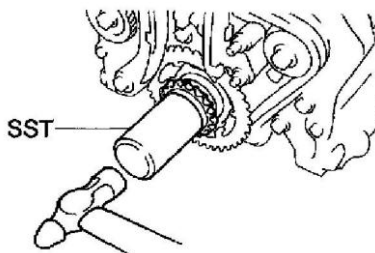

HINT: If necessary, install the sprocket with SST.

8. INSTALL NO.1 TIMING CHAIN AND CAMSHAFT TIMING SPROCKET

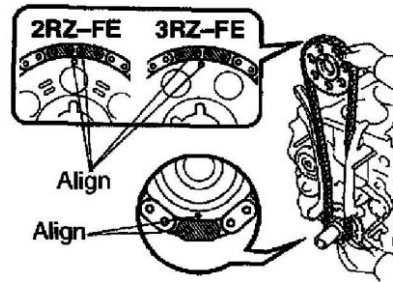

- a. Align the timing mark between the mark link of the No.1 timing chain, and install the No.1 timing chain to the timing sprocket.
- b. Align the timing mark of the crankshaft timing sprocket with the mark link of the No.1 timing chain and install the No.1 timing chain.



- c. Tie the No.1 timing chain with a cord as shown in the illustration, and make sure it doesn't come loose.

9. INSTALL TIMING CHAIN COVER

- a. Install 3 new gaskets to the cylinder block and water bypass pipe.

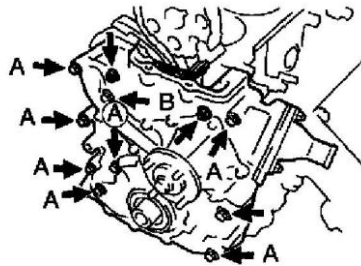

- b. Install the timing chain cover with the 9 bolts and 2 nuts. Torque:
 - 20 Nm (200 kgf-cm, 14 ft. lbs.) for 12 mm head bolt A
 - 24.5 Nm (250 kgf-cm, 18 ft. lbs.) for 12 mm head bolt B
 - 44 Nm (440 kgf-cm, 32 ft. lbs.) for 14 mm head bolt
 - 20 Nm (200 kgf-cm, 14 ft. lbs.) for nut

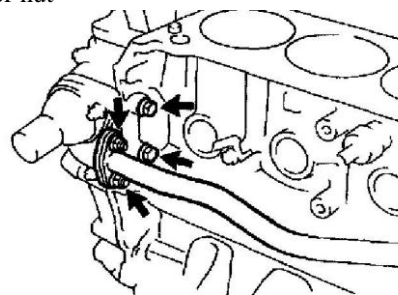

- c. Install the 2 timing chain cover bolts.
Torque: 18 Nm (185 kgf-cm, 13 ft. lbs.)
- d. Install the 2 water bypass pipe nuts.
Torque: 20 Nm (200 kgf-cm, 14 ft. lbs.)

- e. Remove the cord from the chain.
10. INSTALL CRANKSHAFT PULLEY
- a. Align the pulley set key with the key groove of the pulley, and slide on the pulley.

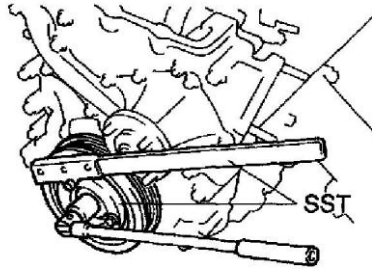

- b. Using SST, install and torque the pulley bolt.
SST 09213-54015, 09330-00021
Torque: 260 Nm (2,650 kgf-cm, 193 ft. lbs.)
- c. w/ A/C: Install the No.3 and No.2 crankshaft pulleys with the 4 bolts.
Torque: 25 Nm (250 kgf-cm, 18 ft. lbs.)
11. INSTALL OIL STRAINER

Install a new gasket and the oil strainer with the bolt and 2 nuts. Torque: 18 Nm (185 kgf-cm, 13 ft. lbs.)

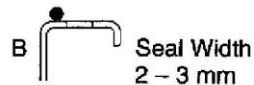
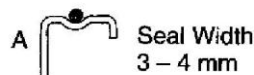
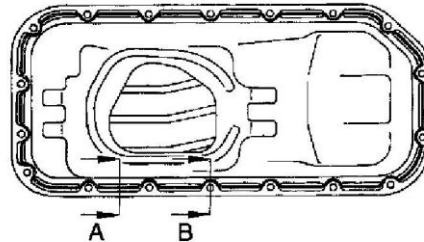

12. INSTALL OIL PAN
- a. Remove any old packing (FIPG) material and be careful not to drop any oil on the contact surface of the oil pan. Using a razor blade and gasket scraper, remove all the old packing (FIPG) material from the gasket surfaces and sealing grooves. Thoroughly clean all components to remove all the loose material. Using a non-residue solvent, clean both sealing surfaces.

NOTICE: Do not use a solvent which will affect the painted surfaces.

- b. Apply seal packing to the oil pan as shown in the illustration.
Seal packing: Part No. 08826-00080 or equivalent
Install a nozzle that has been cut to a 2 - 3 mm (0.08 - 0.12 inch) opening or 3 - 4 mm (0.012 - 0.016 inch) opening.

HINT: Avoid applying an excessive amount to the surface.

- Parts must be assembled within 5 minutes of application. Otherwise the material must be removed and reapplied.
 - Immediately remove nozzle from the tube and rein stall cap.
- c. Install the oil pan with the 16 bolts and 2 nuts.

Torque: 12.5 Nm (130 kgf-cm, 9 ft. lbs.)

13. INSTALL FLYWHEEL HOUSING UNDER COVER AND DUST SEAL

14. 2 WD: INSTALL STIFFENER PLATES

Torque: 37 Nm (380 kgf-cm, 27 ft. lbs.)

15. INSTALL CRANKSHAFT POSITION SENSOR

Install a new O-ring.

Torque: 8.5 Nm (85 kgf-cm, 74 inch lbs.)

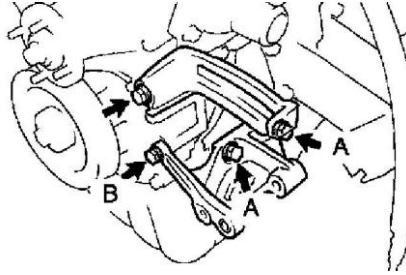

16. INSTALL GENERATOR, ADJUSTING BAR AND BRACKET

a. Install the bracket with the
3 bolts. Torque:

74.5 Nm (760 kgf-cm, 55 ft. lbs.) for bolt A

18 Nm (185 kgf-cm, 13 ft. lbs.) for bolt B

b. Install the adjusting bar with the bolt.

Torque: 63.5 Nm (650 kgf-cm, 47 ft. lbs.)

c. Install the generator with the pivot bolt and lock bolt.

17. INSTALL A/C COMPRESSOR AND BRACKET

a. Install the A/C compressor bracket with the 4 bolts.

Torque: 44 Nm (440 kgf-cm, 32 ft. lbs.)

b. Install the A/C compressor with the 4 bolts.

Torque: 25 Nm (250 kgf-cm, 18 ft. lbs.)

18. INSTALL CYLINDER HEAD ASSEMBLY

19. INSTALL WATER PUMP PULLEY, FAN WITH FLUID COUPLING AND DRIVE BELT FOR GENERATOR

20. 4 WD: INSTALL FRONT DIFFERENTIAL AND DRIVE SHAFTS ASSEMBLY

21. FILL WITH ENGINE OIL

22. START ENGINE AND CHECK FOR LEAKS

23. INSTALL ENGINE UNDER COVER

24. VEHICLE ROAD TEST

Check for abnormal noise, shock slippage, correct shift points and smooth operation.

25. RECHECK ENGINE COOLANT AND ENGINE OIL LEVEL